

70250210	DATA SHEET	
Valid from: 13.05.2019	EPIC® ULTRA H-B 10 TS QB	

Description

- Housing H-B ULTRA: For more reliability
- Optimal, low resistance 360° screening
- EPIC® ULTRA housings are universally applicable due to their high corrosion resistance and high protection against environmental influences. Space-saving due to compact dimensions
- High mechanical resistance
- Puggable with standard-housing



General Characteristics

Series	ULTRA H-B 10
Model	Hood
Cable entry	1x lateral
Cable gland	Yes
Clamping range	See table
Screen contacting	BRUSH (optional, see table)
Diameter above cable braiding (only BRUSH)	min. 6 mm
Locking	Bolts for double lever
Protection (DIN EN 60529)	IP 68 (mated and latched)
Protection (NEMA 250/UL50E)	4, 4X, 12 (mated and latched)
Temperature range	-40°C to +100°C

Materials / Surfaces

Housing	Zinc alloy, nickel-plated
Locking	Stainless steel
Cable gland	Brass, nickel-plated
Insert	PA
Seal ring	CR

Standards

Safety standards	IEC 61984
Product features according to	DIN EN 6988
	DIN EN ISO 9227, method NSS, duration 480h
	DIN EN 60068-2-52, severity level 2

Versions

Article number	Article description	Clamping range	BRUSH
70250210	EPIC® ULTRA H-B 10 TS QB 7-15	7 - 15 mm	No
70250265	EPIC® ULTRA H-B 10 TS QB 7-15 BRUSH	7 - 15 mm	Yes
70250211	EPIC® ULTRA H-B 10 TS QB 11-21	11 - 21 mm	No
70250212	EPIC® ULTRA H-B 10 TS QB 11-21 BRUSH	11 - 21 mm	Yes

Creator: BEGE1/PDP Released: IVSE1/PDP	Document: DB70250210EN Version: 02	Page 1 of 2
---	---------------------------------------	-------------

70250210	DATA SHEET	
Valid from: 13.05.2019	EPIC® ULTRA H-B 10 TS QB	

Technical Drawings

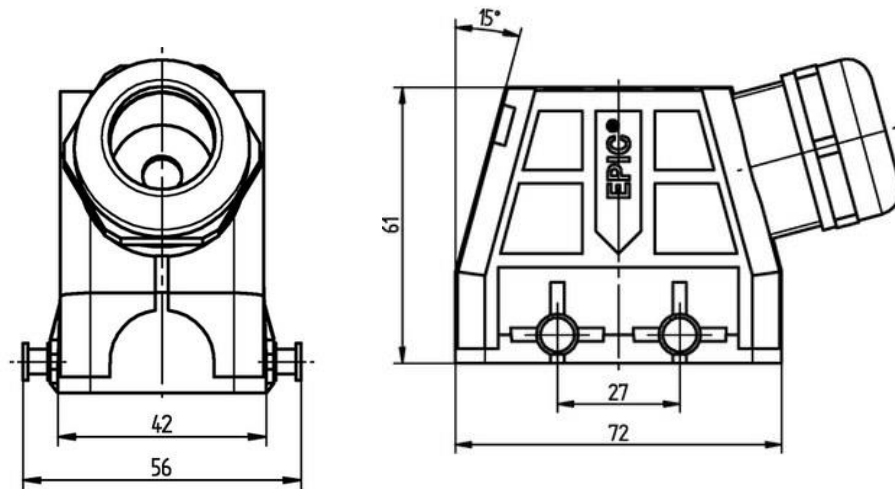

Good chemical resistance



Required space



Large clamping range



Robust



Corrosion resistant



SKINTOP® Integrated Cable Gland



Installation time



Connectors with standart housing

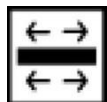

Optimal strain relief



Waterproof

Info

EMC protection, corrosion-resistant, integrated SKINTOP® cable gland

Application range

In EMC-sensitive environments, for fixed and flexible applications (e.g. machiner, wind turbines), construction machinery, electric motor manufacturing

Remark

Photographs are not to scale and do not represent detailed images of the respective products.

Creator: BEGE1/PDP Released: IVSE1/PDP	Document: DB70250210EN Version: 02	Page 2 of 2
---	---------------------------------------	-------------